

# From the Einstein-Bohr debate to Quantum Information: a second quantum revolution

## Niels Bohr 1913-2013

Séminaire Poincaré  
“Bourbaphy”  
IHP - 7/12/2013



Alain Aspect, Institut d'Optique, Palaiseau

<http://www.lcf.institutoptique.fr/Alain-Aspect-homepage>

# Quantum information: a flourishing field

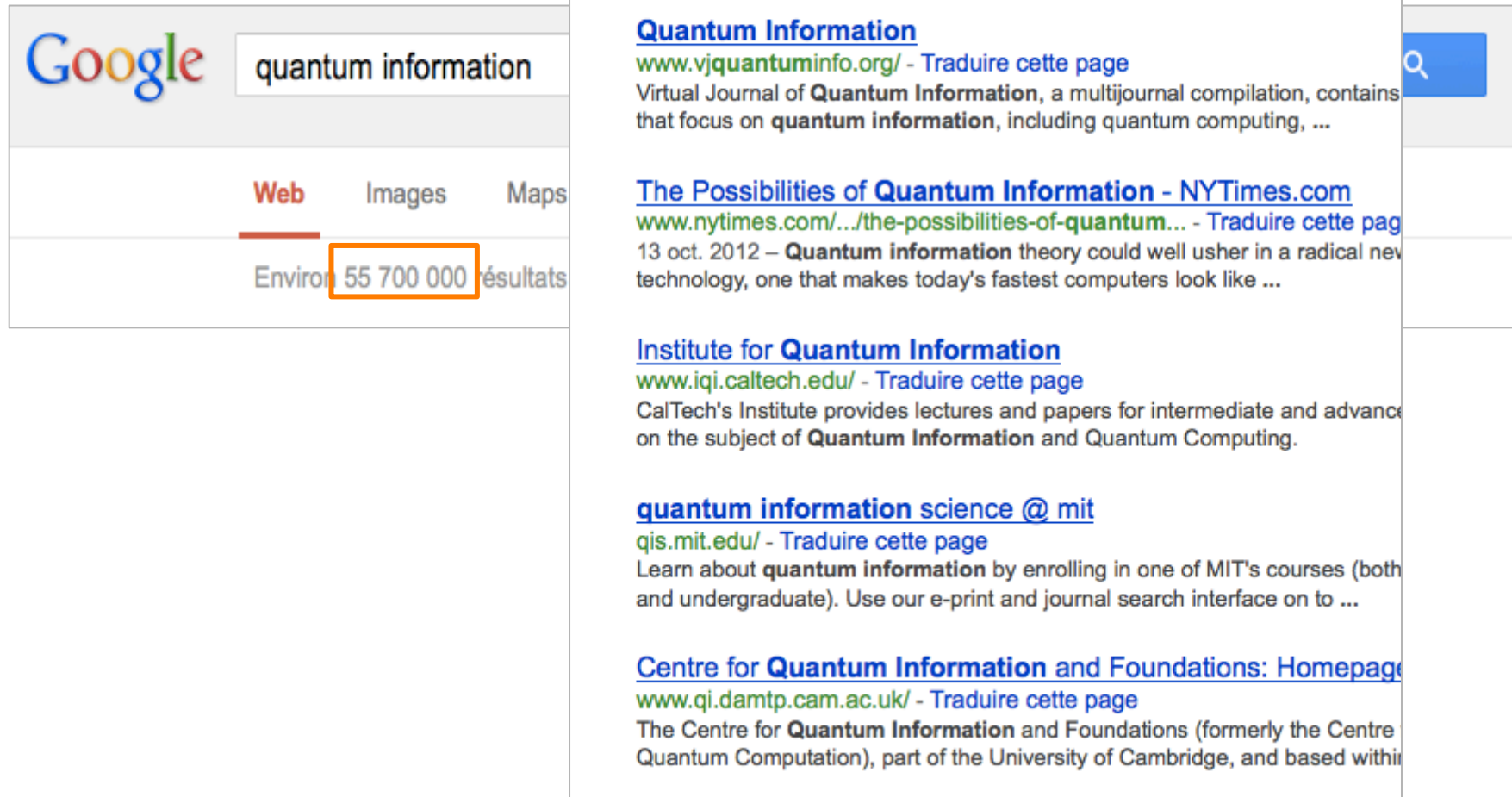

The image shows a screenshot of a Google search interface. The search bar contains the text "quantum information". Below the search bar, there are tabs for "Web", "Images", and "Maps". The "Web" tab is selected. Below the tabs, the text "Environ 55 700 000 résultats" is displayed, with the number "55 700 000" highlighted in an orange box. To the right of the search bar, there is a blue search button with a magnifying glass icon. The search results are displayed in a list format, with each result including a title, a URL, and a brief description. The results are:

- Quantum Information**  
[www.vjquantuminfo.org/](http://www.vjquantuminfo.org/) - Traduire cette page  
Virtual Journal of **Quantum Information**, a multijournal compilation, contains that focus on **quantum information**, including quantum computing, ...
- The Possibilities of Quantum Information - NYTimes.com**  
[www.nytimes.com/.../the-possibilities-of-quantum...](http://www.nytimes.com/.../the-possibilities-of-quantum...) - Traduire cette page  
13 oct. 2012 – **Quantum information** theory could well usher in a radical new technology, one that makes today's fastest computers look like ...
- Institute for Quantum Information**  
[www.iqi.caltech.edu/](http://www.iqi.caltech.edu/) - Traduire cette page  
CalTech's Institute provides lectures and papers for intermediate and advanced on the subject of **Quantum Information** and Quantum Computing.
- quantum information science @ mit**  
[qis.mit.edu/](http://qis.mit.edu/) - Traduire cette page  
Learn about **quantum information** by enrolling in one of MIT's courses (both and undergraduate). Use our e-print and journal search interface on to ...
- Centre for Quantum Information and Foundations: Homepage**  
[www.qi.damtp.cam.ac.uk/](http://www.qi.damtp.cam.ac.uk/) - Traduire cette page  
The Centre for **Quantum Information** and Foundations (formerly the Centre Quantum Computation), part of the University of Cambridge, and based within

How did it emerge?

# Quantum information: how did it emerge?

## Entanglement discovery in 1935

MAY 15, 1935

PHYSICAL REVIEW

VOLUME 47

### Can Quantum-Mechanical Description of Physical Reality Be Considered Complete?

A. EINSTEIN, B. PODOLSKY AND N. ROSEN, *Institute for Advanced Study, Princeton, New Jersey*  
(Received March 25, 1935)



Proceedings of the Cambridge Philosophical Society, 1935 - hep.princeton.edu

### DISCUSSION OF PROBABILITY RELATIONS BETWEEN SEPARATED SYSTEMS

By E. SCHRÖDINGER

[Communicated by Mr M. BORN]

OCTOBER 15, 1935

PHYSICAL REVIEW

VOLUME 48

### Can Quantum-Mechanical Description of Physical Reality be Considered Complete?

N. BOHR, *Institute for Theoretical Physics, University, Copenhagen*  
(Received July 13, 1935)

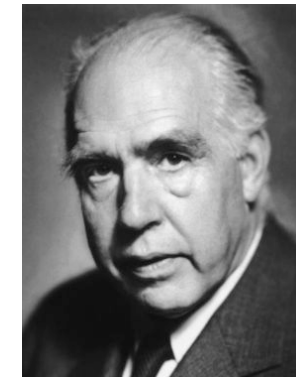

# Quantum information: how did it emerge?

Entanglement is different: Bell's inequalities (1964)

Physics Vol. 1, No. 3, pp. 195–240, 1964 Physics Publishing Co. Printed in the United States  
ON THE EINSTEIN PODOLSKY ROSEN PARADOX\*  
J. S. BELL,<sup>†</sup>  
*Department of Physics, University of Wisconsin, Madison, Wisconsin*  
<sup>†</sup>On leave of absence from SLAC and CERN



# Quantum information: how did it emerge?

Entanglement is different: Bell's inequalities (1964)

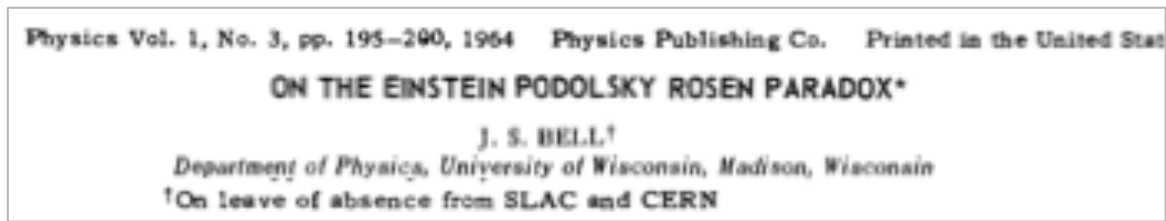

Entanglement is more: can (must) be used for solving 'difficult' problems (Feynman, 1982)

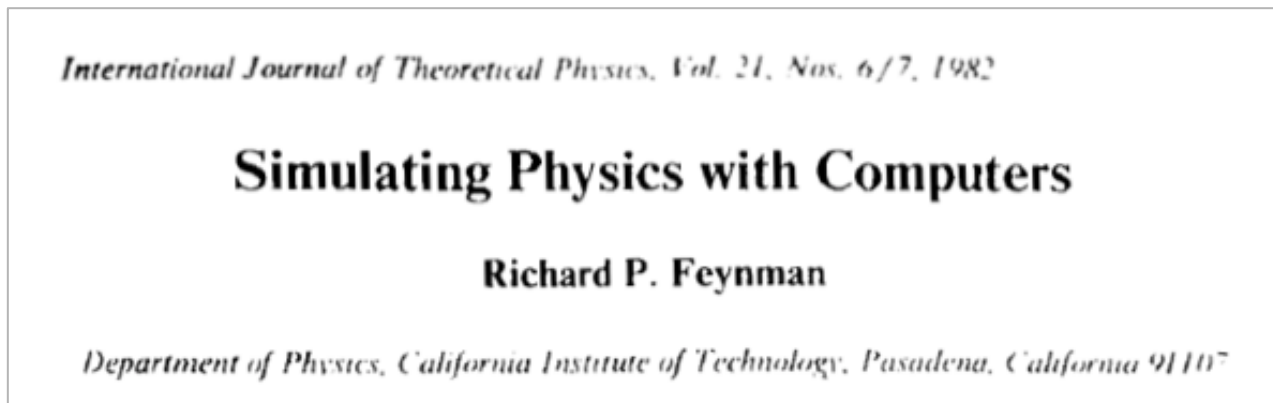

# From the Einstein-Bohr debate to Quantum Information: a second quantum revolution?

1. The EPR paper and Bohr's reply: entanglement
2. Bell's Theorem: entanglement is different
3. Quantum information: entanglement is more

# From the Einstein-Bohr debate to Quantum Information: a second quantum revolution?

1. The EPR paper and Bohr's reply: entanglement
2. Bell's Theorem: entanglement is different
3. Quantum information: entanglement is more

# The Einstein-Podolsky Rosen paper

MAY 15, 1935

PHYSICAL REVIEW

VOLUME 47

## Can Quantum-Mechanical Description of Physical Reality Be Considered Complete?

A. EINSTEIN, B. PODOLSKY AND N. ROSEN, *Institute for Advanced Study, Princeton, New Jersey*

(Received March 25, 1935)

Quantum formalism allows for the 2-particles state:

$$\Psi(1,2) = 2\pi \delta(x_1 - x_2 + x_0) = \int dp e^{\frac{iP}{\hbar}(x_1 - x_2 + x_0)} = e^{\frac{iP}{\hbar}x_0} \int dp u_p(x_1) u_{-p}(x_2)$$

- If one measures the **position** of 1, and finds  $x_1$ , then a measurement of the **position** of 2 will give **with certainty**  $x_2 = x_1 + x_0$
- But the measurement on 1 cannot affect the situation of 2, which is far apart (space-like separated) : **particle 2 had a well defined value of its position before the measurement.**
- This is not in the formalism: **the formalism is incomplete**

Moreover...



# The Einstein-Podolsky Rosen paper

Moreover...

$$\Psi(1,2) = 2\pi \delta(x_1 - x_2 + x_0) = \int dp e^{i\frac{p}{\hbar}(x_1 - x_2 + x_0)} = e^{i\frac{p}{\hbar}x_0} \int dp u_p(x_1) u_{-p}(x_2)$$

- If one measures the **momentum** of 1, and finds  $p$ , then a measurement of the **momentum** of 2 will give **with certainty**  $-p$
- **But the measurement on 1 cannot affect the situation of 2, which is far apart (space-like separated) : particle 2 had a well defined value of its momentum before the measurement.**

The **position** and **momentum** of particle 2 **were perfectly determined before any measurement.** **Heisenberg relations?**

The physical reality is better defined than indicated by the Quantum formalism. **The Quantum formalism is incomplete**

# Schrödinger: entanglement paradoxical

Proceedings of the Cambridge Philosophical Society, 1935 - hep.princeton.edu

DISCUSSION OF PROBABILITY RELATIONS BETWEEN  
SEPARATED SYSTEMS

BY E. SCHRÖDINGER

Received 14 August, read by M Born 28 October

*'By the interaction the two representatives (or  $\psi$ -functions) have become **entangled**.'*

*'After re-establishing one representative by observation, the other one can be inferred **simultaneously**.'*

*'Attention has recently\* been called to the obvious but very disconcerting fact that even though we restrict the disentangling measurements to one system, the representative obtained for the other system is by no means independent of the particular choice of observations which we select for that purpose... **This paper does not aim at a solution of the paradox, it rather adds to it, if possible.**'*

\* EPR paper

# Bohr (1935): a bolt in the blue

Rosenfeld: *`This onslaught came down upon us as a bolt from the blue. Its effect on Bohr was remarkable. ... everything else was abandoned: we had to clear up such a misunderstanding at once... [Next day] there was no trace... of the previous day's sharp expressions of dissent. As I pointed out to him that he seemed to take a milder view of the case, he smiled: "That's a sign", he said, "that we are beginning to understand the problem."*

OCTOBER 15, 1935

PHYSICAL REVIEW

VOLUME 48

## Can Quantum-Mechanical Description of Physical Reality be Considered Complete?

N. BOHR, *Institute for Theoretical Physics, University, Copenhagen*

(Received July 13, 1935)

# Bohr's reply to EPR: complementarity

OCTOBER 15, 1935

PHYSICAL REVIEW

VOLUME 48

## Can Quantum-Mechanical Description of Physical Reality be Considered Complete?

N. BOHR, *Institute for Theoretical Physics, University, Copenhagen*

(Received July 13, 1935)

*'a viewpoint termed "**complementarity**" is explained from which quantum-mechanical description of physical phenomena would seem to fulfill, within its scope, all rational demands of completeness'*

**Complementarity allows one to avoid the problem:**

one has to choose the observable one measures on the first EPR particle, and it is only the value of that observable that can be known with certainty for the second particle, even though it is far apart.

*'if we choose to measure the **momentum** of one of the particles, we lose any possibility of deducing from the behavior of this particle ... the **location** of the other particle.'*

# Bohr's reply to EPR: complementarity is necessary

OCTOBER 15, 1935

PHYSICAL REVIEW

VOLUME 48

## Can Quantum-Mechanical Description of Physical Reality be Considered Complete?

N. BOHR, *Institute for Theoretical Physics, University, Copenhagen*

(Received July 13, 1935)

Moreover complementarity is necessary to the new physics

*'In fact, it is only the mutual exclusion of any two experimental procedures, permitting the unambiguous definition of complementary physical quantities, which provides room for new physical laws'*

One can interpret Bohr's wording as: Quantum Mechanics would fall apart if it was completed as suggested by EPR.

# A debate for many decades

Intense debate between Bohr and Einstein...

... without much attention from a majority of physicists



- Quantum mechanics accumulates success:
  - **Understanding nature:** structure and properties of matter, light, and their interaction (atoms, molecules, absorption, spontaneous emission, solid properties, superconductivity, superfluidity, elementary particles ...)
  - **New concepts** leading to **revolutionary inventions:** transistor (later: laser, integrated circuits...)
- No disagreement on the **validity** of quantum predictions, only on its **interpretation**.

# From the Einstein-Bohr debate to Quantum Information: a second quantum revolution?

1. The EPR paper and Bohr's reply: entanglement
2. **Bell's Theorem:** entanglement is different
3. Quantum information: entanglement is more

# The EPR-Bohm GedankenExperiment with photons correlated in polarization: dichotomic observables

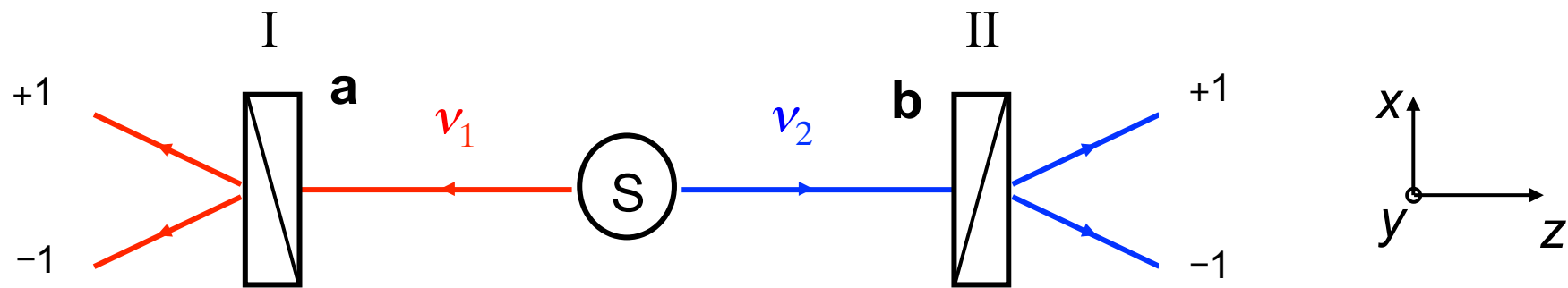

Measurement of the polarization of  $v_1$  along orientation  $\mathbf{a}$  and of polarization of  $v_2$  along orientation  $\mathbf{b}$  : results  $+1$  or  $-1$

- Probabilities to find  $+1$  ou  $-1$  for  $v_1$  (measured along  $\mathbf{a}$ ) and  $+1$  or  $-1$  for  $v_2$  (measured along  $\mathbf{b}$ ).

Single probabilities

$$P_+(\mathbf{a}), P_-(\mathbf{a})$$

$$P_+(\mathbf{b}), P_-(\mathbf{b})$$

Joint probabilities

$$P_{++}(\mathbf{a}, \mathbf{b}), P_{+-}(\mathbf{a}, \mathbf{b})$$

$$P_{-+}(\mathbf{a}, \mathbf{b}), P_{--}(\mathbf{a}, \mathbf{b})$$



# The EPR GedankenExperiment with photons correlated in polarization

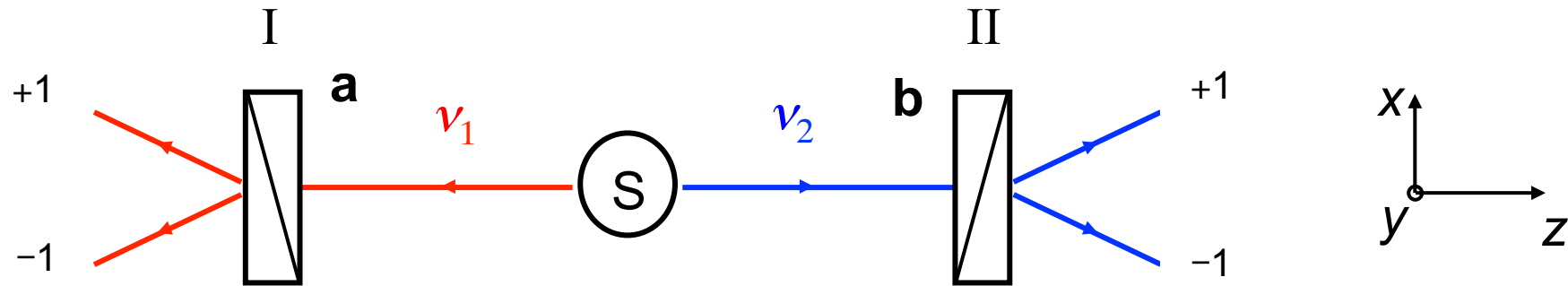

For the entangled EPR state...  $|\Psi(\nu_1, \nu_2)\rangle = \frac{1}{\sqrt{2}} \{ |x, x\rangle + |y, y\rangle \}$

Quantum mechanics predicts  
results separately random ...

$$P_+(\mathbf{a}) = P_-(\mathbf{a}) = \frac{1}{2} ; P_+(\mathbf{b}) = P_-(\mathbf{b}) = \frac{1}{2}$$

but  
strongly  
correlated:

$$P_{++}(\mathbf{a}, \mathbf{b}) = P_{--}(\mathbf{a}, \mathbf{b}) = \frac{1}{2} \cos^2(\mathbf{a}, \mathbf{b})$$

$$P_{+-}(\mathbf{a}, \mathbf{b}) = P_{-+}(\mathbf{a}, \mathbf{b}) = \frac{1}{2} \sin^2(\mathbf{a}, \mathbf{b})$$

$$P_{++}(0) = P_{--}(0) = \frac{1}{2}$$

$$P_{+-}(0) = P_{-+}(0) = 0$$

# Coefficient of correlation of polarization (EPR state)

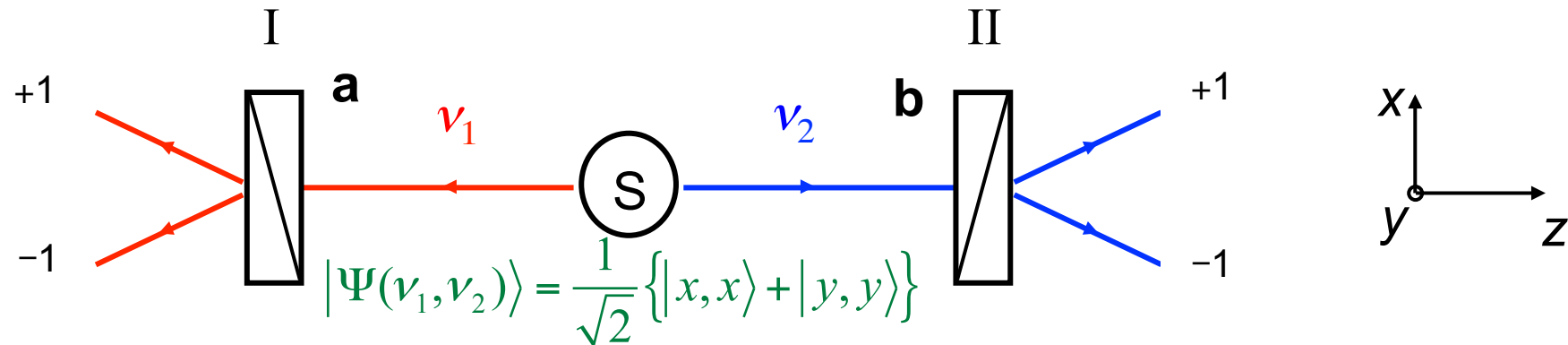

Quantitative expression of the **correlations** between results of measurements in I et II: **coefficient**:

$$E = P_{++} + P_{--} - P_{+-} - P_{-+} = P(\text{résultats id}^\circ) - P(\text{résultats } \neq)$$

QM predicts, for parallel polarizers (a,b) = 0	$P_{++} = P_{--} = \frac{1}{2}$  $P_{+-} = P_{-+} = 0$	$\Rightarrow E_{MQ} = 1$  Total correlation
------------------------------------------------------	--------------------------------------------------------------	---------------------------------------------------

More generally, for an arbitrary angle (a,b) between polarizers

$$E_{MQ}(\mathbf{a}, \mathbf{b}) = \cos 2(\mathbf{a}, \mathbf{b})$$

# How to “understand” the EPR correlations predicted by quantum mechanics?

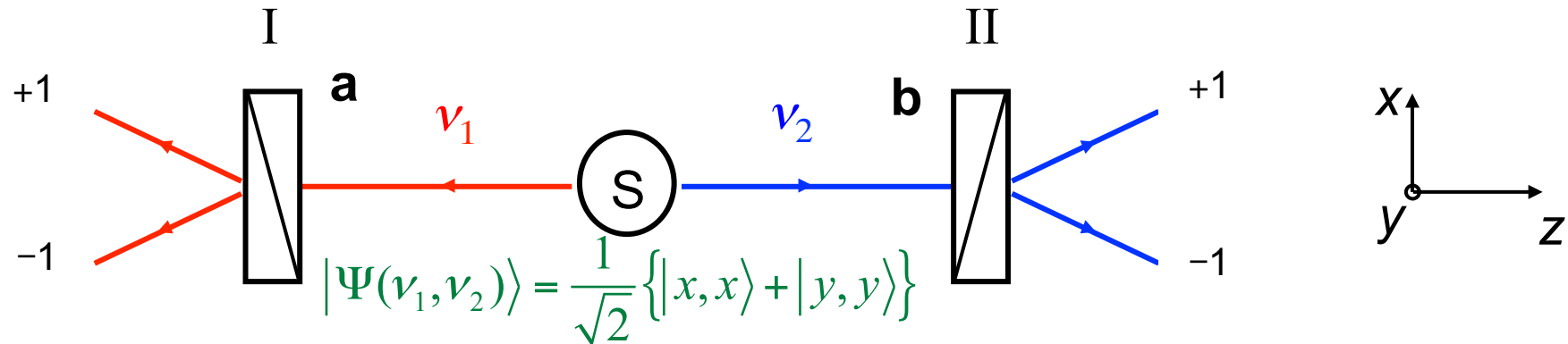

$$E_{MQ}(\mathbf{a}, \mathbf{b}) = \cos 2(\mathbf{a}, \mathbf{b})$$

Can we derive an image from the QM calculation?

# How to “understand” the EPR correlations predicted by quantum mechanics?

Can we derive an image from the QM calculation?

The direct calculation  $P_{++}(\mathbf{a}, \mathbf{b}) = |\langle +_{\mathbf{a}}, +_{\mathbf{b}} | \Psi(\nu_1, \nu_2) \rangle|^2 = \frac{1}{2} \cos^2(\mathbf{a}, \mathbf{b})$  is done in an abstract space, where the two particles are described globally: impossible to extract an image in real space where the two photons are separated.

Related to the non factorability of the entangled state:

$$|\Psi(\nu_1, \nu_2)\rangle = \frac{1}{\sqrt{2}} \{ |x, x\rangle + |y, y\rangle \} \neq |\phi(\nu_1)\rangle \cdot |\chi(\nu_2)\rangle$$

One cannot identify properties attached to each photon separately

“Quantum phenomena do not occur in a Hilbert space, they occur in a laboratory” (A. Peres)  $\Rightarrow$  An image in real space?

# A real space image of the EPR correlations derived from a quantum calculation

2 step calculation (standard QM)

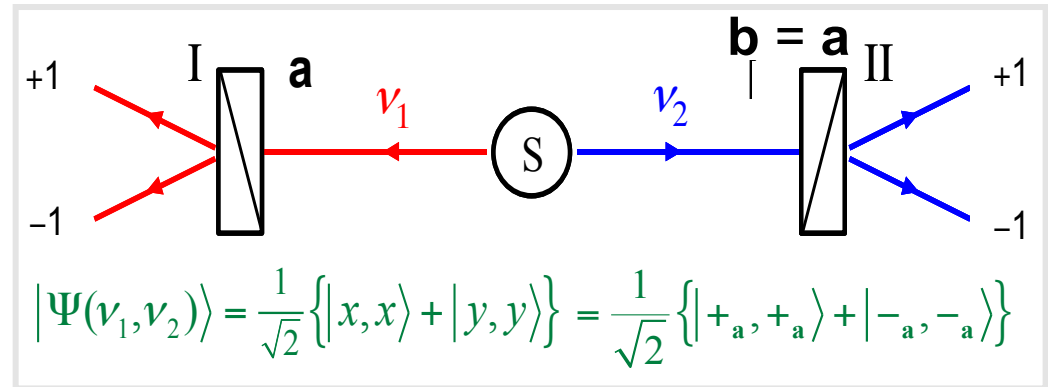

1) Measure on  $v_1$  by I (along  $\mathbf{a}$ )

$\Rightarrow$  result  $+1$   $|+_a\rangle$   
 or  
 $\Rightarrow$  result  $-1$   $|-_a\rangle$

Just after the measure, “collapse of the state vector”: projection onto the eigenspace associated to the result

$|+_a, +_a\rangle$   
 or  
 $|-_a, -_a\rangle$

2) Measure on  $v_2$  by II (along  $\mathbf{b} = \mathbf{a}$ )

- If one has found  $+1$  for  $v_1$  then the state of  $v_2$  is  $|+_a\rangle$  and the measurement along  $\mathbf{b} = \mathbf{a}$  yields  $+1$ ;
- If one has found  $-1$  for  $v_1$  then the state of  $v_2$  is  $|-_a\rangle$  and the measurement along  $\mathbf{b} = \mathbf{a}$  yields  $-1$ ;

Easily generalized to  $\mathbf{b} \neq \mathbf{a}$  (Malus law)

The measurement on  $v_1$  seems to influence instantaneously at a distance the state of  $v_2$  : unacceptable for Einstein (relativistic causality).

# A classical image for the correlations at a distance (suggested by the EPR reasoning)

- The two photons of the same pair bear from their very emission an identical property ( $\lambda$ ), that will determine the results of polarization measurements.
- The property  $\lambda$  differs from one pair to another.

exemple

$$\lambda = +_a$$

ou

$$\lambda = -_a$$

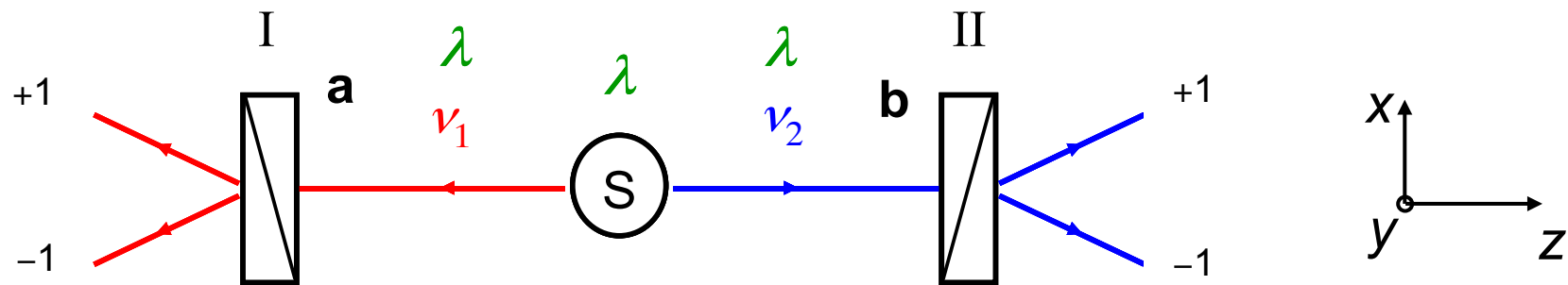
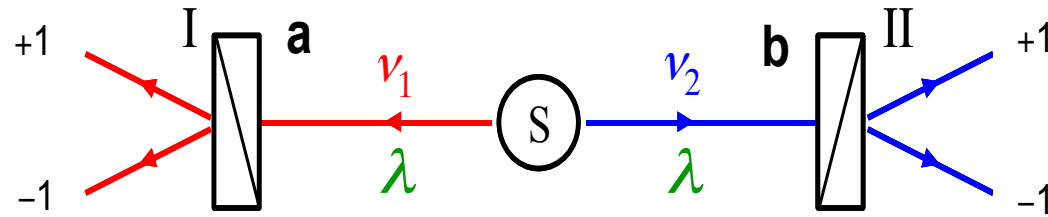

Image simple and convincing (analogue of identical chromosomes for identical twins), but.....amounts to completing quantum formalism:  $\lambda =$  supplementary parameter, “hidden variable”.

⇒ Bohr disagreed: QM description is complete, you cannot add anything to it

# 1964: Bell's formalism



Consider **local supplementary parameters theories** (in the spirit of Einstein's ideas on EPR correlations):

- The two photons of a same pair have a common property  $\lambda$  (sup. param.) determined at the joint emission
- The supplementary parameter  $\lambda$  determines the results of measurements at I and II  $\Leftrightarrow$ 

$$A(\lambda, \mathbf{a}) = +1 \text{ or } -1 \text{ at polarizer I}$$

$$B(\lambda, \mathbf{b}) = +1 \text{ or } -1 \text{ at polarizer II}$$
- The supplementary parameter  $\lambda$  is randomly distributed among pairs  $\Leftrightarrow$ 

$$\rho(\lambda) \geq 0 \text{ and } \int \rho(\lambda) d\lambda = 1$$

at source S

$$E(\mathbf{a}, \mathbf{b}) = \int d\lambda \rho(\lambda) A(\lambda, \mathbf{a}) B(\lambda, \mathbf{b})$$

# 1964: Bell's formalism to explain correlations

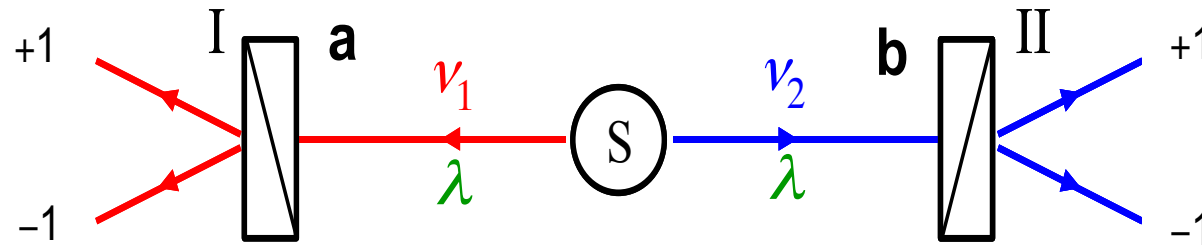

## An example

- Common polarisation  $\lambda$ , randomly distributed among pairs  $\rho(\lambda) = 1/2\pi$
- Result ( $\pm 1$ ) depends on the angle between  $\lambda$  and polarizer orientation (**a** or **b**)

$$A(\lambda, \mathbf{a}) = \text{sign} \{ \cos 2(\theta_a - \lambda) \}$$

$$B(\lambda, \mathbf{b}) = \text{sign} \{ \cos 2(\theta_b - \lambda) \}$$

Resulting correlation

Not bad, but no exact agreement

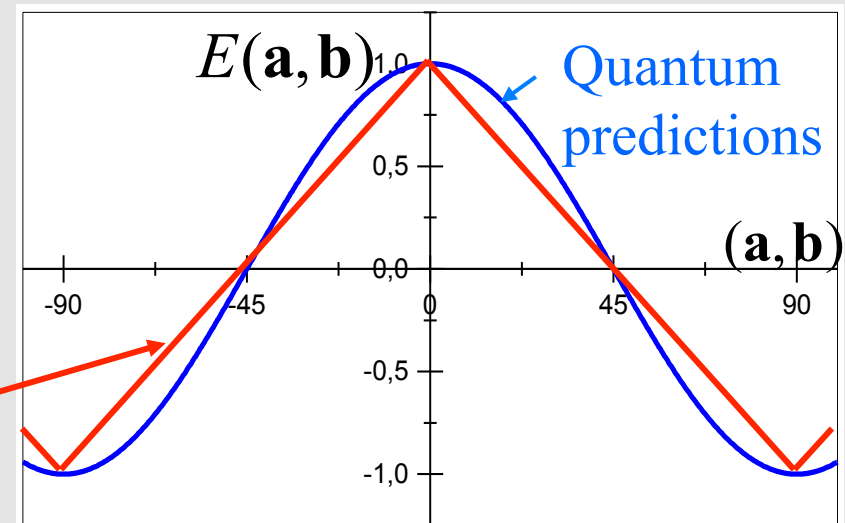

Is there a better model, agreeing with QM predictions at all orientations?

Bell's theorem gives the answer



# Bell's theorem

# No!

No **local hidden variable theory** (in the spirit of Einstein's ideas) can reproduce **quantum mechanical predictions** for EPR correlations at **all** the orientations of polarizers.

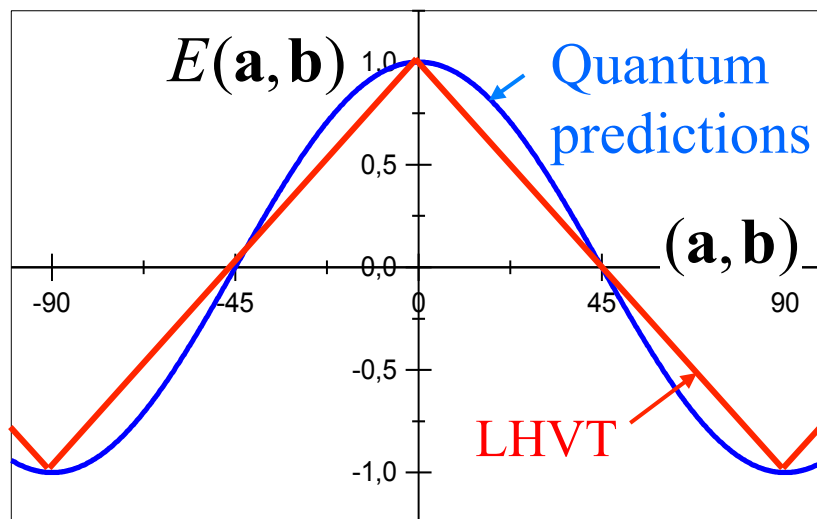

Impossible to cancel the difference everywhere

Impossible to have quantum predictions exactly reproduced at *all* orientations, by any model à la Einstein

# Bell's inequalities are violated by certain quantum predictions

Any local hidden variables theory  $\Rightarrow$  Bell's inequalities

$$-2 \leq S \leq 2 \quad \text{avec} \quad S = E(\mathbf{a}, \mathbf{b}) - E(\mathbf{a}, \mathbf{b}') + E(\mathbf{a}', \mathbf{b}) + E(\mathbf{a}', \mathbf{b}')$$

CHSH inequ. (Clauser, Horne, Shimony, Holt, 1969)

Quantum mechanics  $E_{\text{MQ}}(\mathbf{a}, \mathbf{b}) = \cos 2(\mathbf{a}, \mathbf{b})$

For orientations  $(\mathbf{a}, \mathbf{b}) = (\mathbf{b}, \mathbf{a}') = (\mathbf{a}', \mathbf{b}) = \frac{\pi}{8}$

$$S_{\text{QM}} = 2\sqrt{2} = 2.828... > 2$$

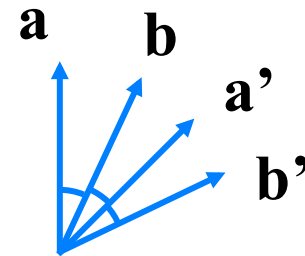

**CONFLICT!** The possibility to complete quantum mechanics according to Einstein ideas is no longer a matter of taste (of interpretation). It has turned into an experimental question.

# Conditions for a conflict

( $\Rightarrow$  hypotheses for Bell's inequalities)

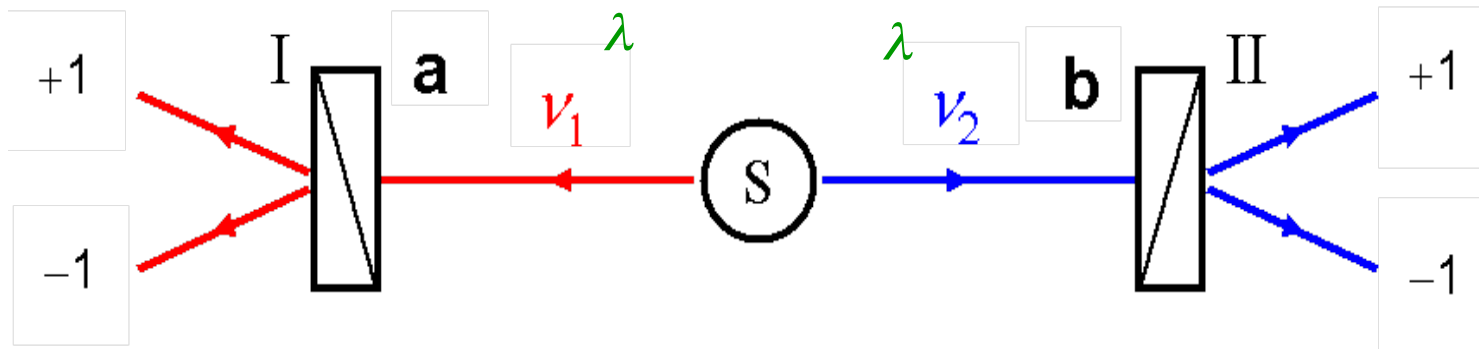

Supplementary parameters  $\lambda$  carried along by each particle.  
Explanation of correlations « à la Einstein » attributing individual properties to each separated particle: **local realist world view**.

**Bell's  
locality  
condition**

- The result  $A(\lambda, \mathbf{a})$  of the measurement on  $v_1$  by I does not depend on the orientation  $\mathbf{b}$  of distant polarizer II (and conv.)
- The distribution  $\rho(\lambda)$  of supplementary parameters over the pairs does not depend on the orientations  $\mathbf{a}$  and  $\mathbf{b}$ .

# Bell's locality condition

$$A(\lambda, \mathbf{a}, \mathbf{b}) \quad B(\lambda, \mathbf{a}, \mathbf{b}) \quad \rho(\lambda, \mathbf{a}, \mathbf{b})$$



can be stated as a reasonable hypothesis, but...

...in an experiment with **variable polarizers** (orientations modified faster than the propagation time  $L/c$  of light between polarizers) Bell's locality condition becomes a consequence of **Einstein's relativistic causality** (no faster than light influence)  
*cf. Bohm & Aharonov, Physical Review, 1957*

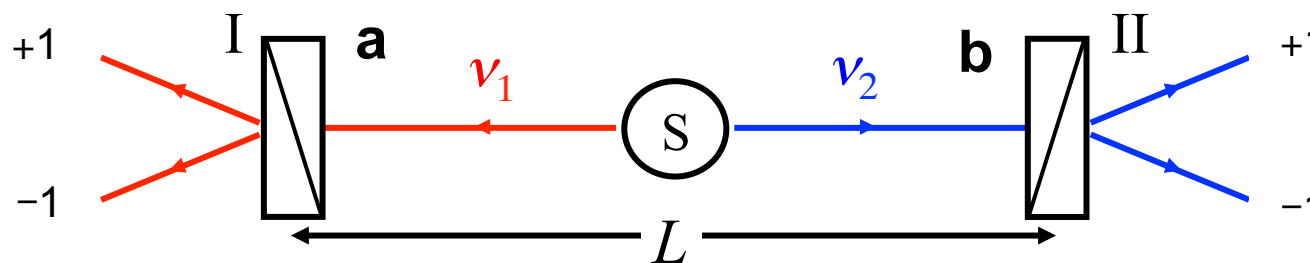

Conflict between **quantum mechanics** and **Einstein's world view** (local realism based on relativity).

# 1964: Bell's theorem

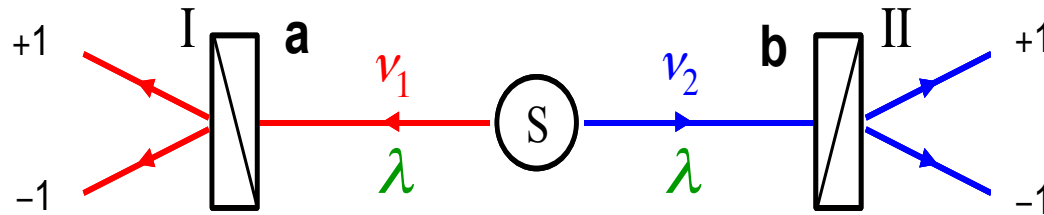

Complete QM with **supplementary parameters** (in the spirit of Einstein's ideas):  $\Rightarrow$  **(Bell's) inequalities**

$$-2 \leq S \leq 2 \quad \text{with} \quad S = E(\mathbf{a}, \mathbf{b}) - E(\mathbf{a}, \mathbf{b}') + E(\mathbf{a}', \mathbf{b}) + E(\mathbf{a}', \mathbf{b}')$$

CHSH ineq. (Clauser, Horne, Shimony, Holt, 1969)  $E =$  correlation coeff

For certain orientations, e.g.  $(\mathbf{a}, \mathbf{b}) = (\mathbf{b}, \mathbf{a}') = (\mathbf{a}', \mathbf{b}) = \frac{\pi}{8}$   
 Quantum Mechanics violates Bell's inequalities

$$E_{\text{MQ}}(\mathbf{a}, \mathbf{b}) = \cos 2(\mathbf{a}, \mathbf{b}) \quad S_{\text{QM}} = 2\sqrt{2} = 2.828... > 2$$

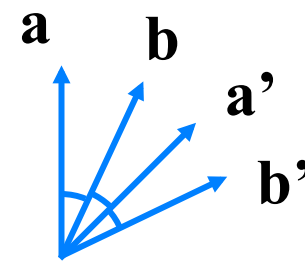

**CONFLICT!** The possibility to complete quantum mechanics according to Einstein ideas is no longer a matter of taste (of interpretation). It has turned into an experimental question.

# Three generations of experiments

**Pioneers** (1972-76): Berkeley, Harvard, Texas A&M

- First results contradictory (Clauser = QM; Pipkin  $\neq$  QM)
- Clear trend in favour of Quantum mechanics (Clauser, Fry)
- Experiments significantly different from the ideal scheme

**Institut d'optique experiments** (1975-82)

- A source of entangled photons of unprecedented efficiency
- Schemes closer and closer to the ideal GedankenExperiment
- Test of quantum non locality (relativistic separation)

**Third generation experiments** (1988-): Maryland, Rochester, Malvern, Genève, Innsbruck, Los Alamos, Boulder, Urbana Champaign...

- New sources of entangled pairs
- Closure of the last loopholes
- Entanglement at large distance
- Entanglement on demand

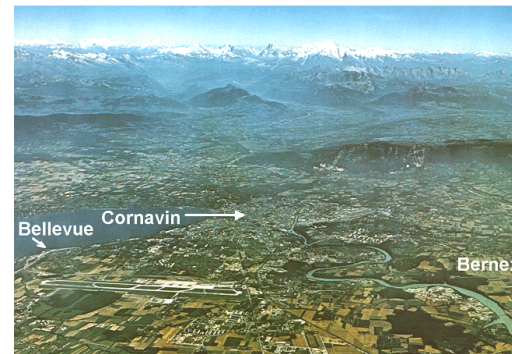



# Orsay's source of pairs of entangled photons (1981)

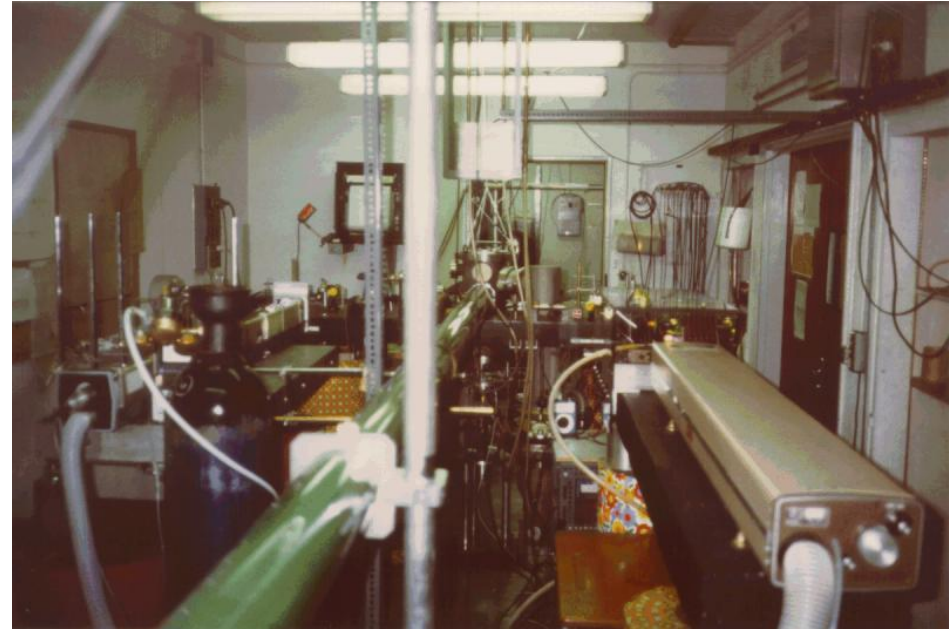
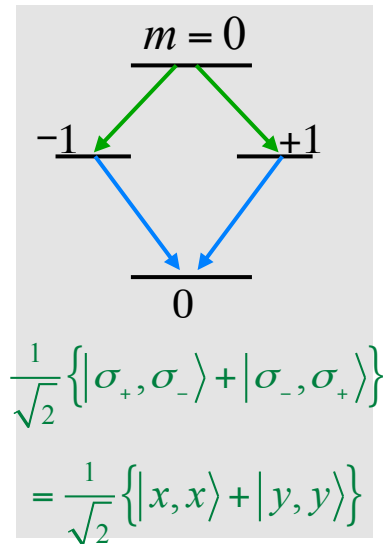
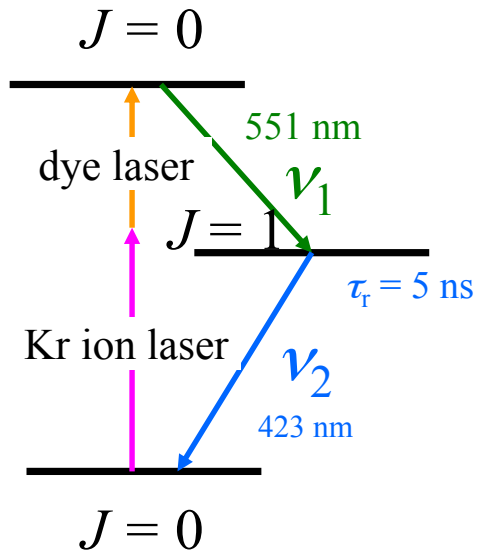

## Two photon selective excitation

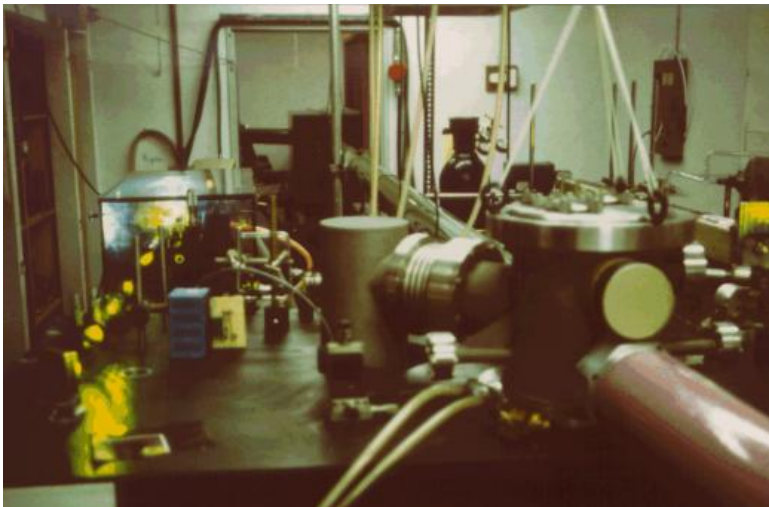

☺ 100 coincidences per second  
1% precision for 100 s counting

Scheme similar to previous experiments  
but Polarizers at 6 m from the source:  
violation of Bell's inequalities,  
entanglement survives "large" distance

# Experimental schemes close to ideal GedankenExperiment

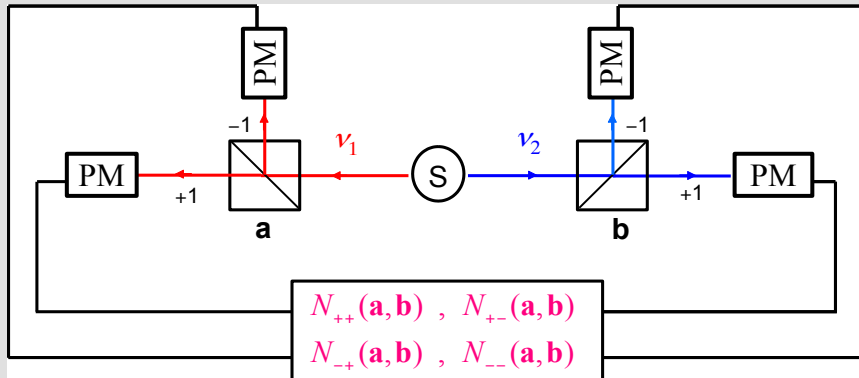

Genuine two-channel polarizers  
(AA, G Roger, P Grangier, 1982)

Violation of Bell's inequalities  
 $S \leq 2$  by more than  $40 \sigma$

$$S_{\text{exp}}(\theta) = 2.697 \pm 0.015$$

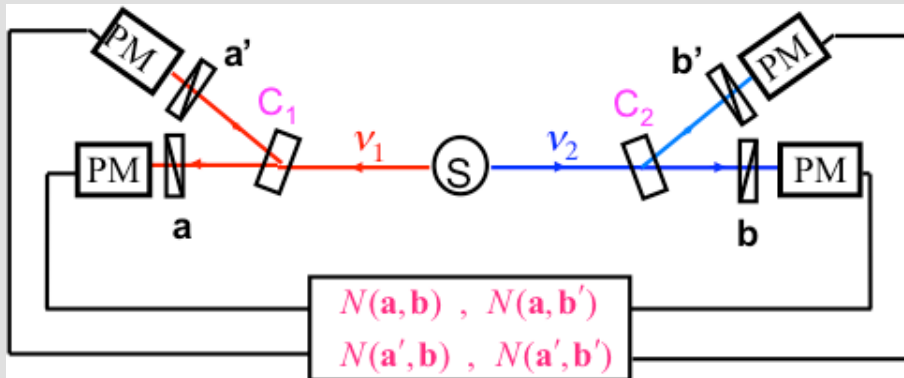

Fast switches: relativistic  
separation of measurements

(AA, G Roger, J Dalibard, 1982)

Clear violation of BI by  $6 \sigma$

Einstein's world views untenable.  
Entanglement extraordinary



# Third generation experiments

Entangled photon pairs by parametric down conversion, well defined directions: injected into optical fibers.

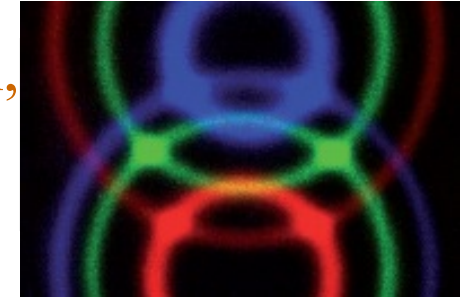

Entanglement at a very large distance

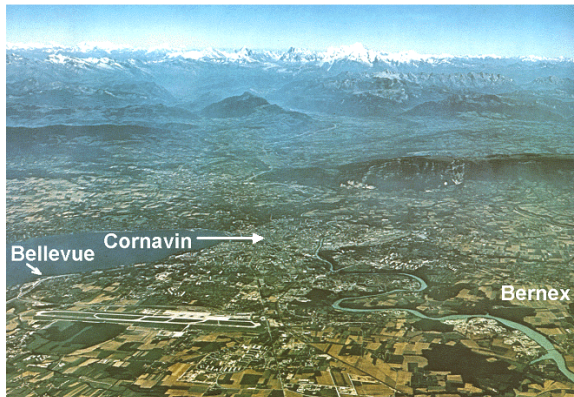

Geneva experiment (1998):

- Optical fibers of the commercial telecom network
- Measurements separated by 30 km

Agreement with QM.

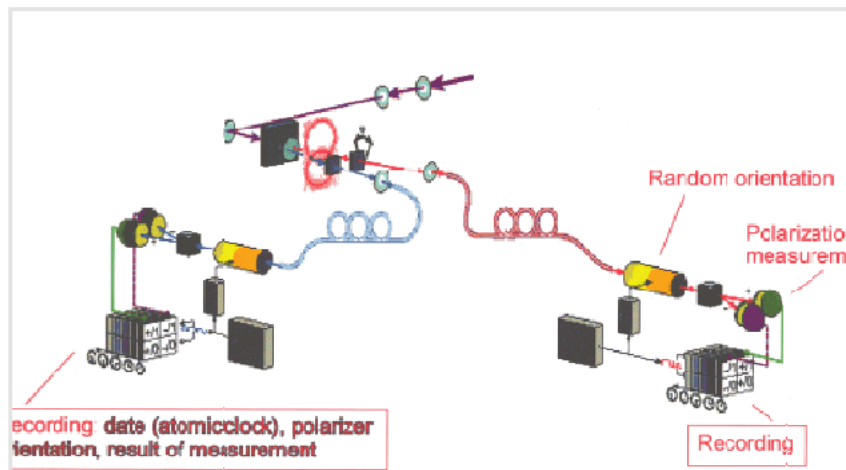

Innsbruck experiment (1998): orientations chosen by a random generator during the propagation (several hundreds meters).

Agreement with QM (first repetition of 1982 experiment)

# Bell's inequalities have been violated in almost ideal experiments

Results in agreement with quantum mechanics in experiments closer and closer to the GedankenExperiment:

- Sources of entangled photons more and more efficient
- Relativistic separation of measurements with variable polarizers (Orsay 1982, Innsbruck 1998); closure of locality loophole
- Experiment with trapped ions (Boulder 2000): closure of the “sensitivity loophole” (recent experiments with photons in Vienna, Urbana Champaign).

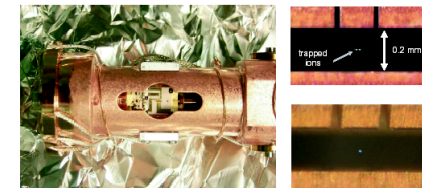
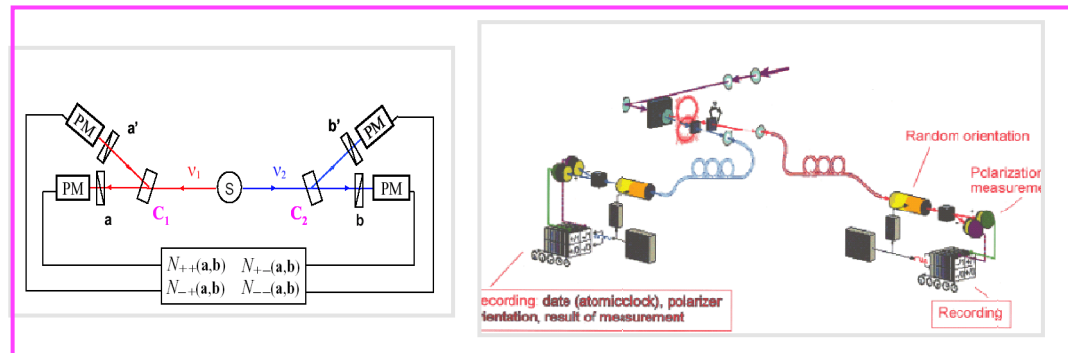
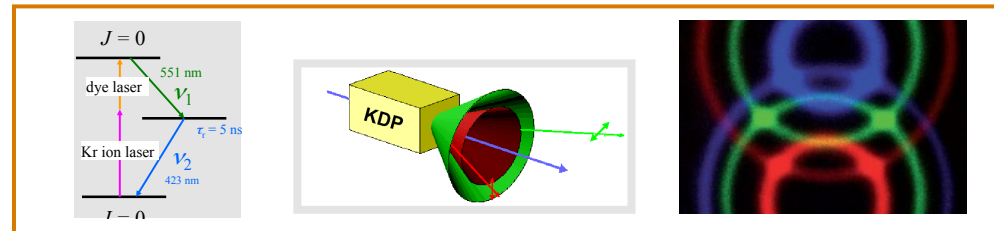

Entanglement definitely weird!

# From the Einstein-Bohr debate to Quantum Information: a second quantum revolution?

1. The EPR paper and Bohr's reply: entanglement
2. Bell's Theorem: entanglement is different
3. **Quantum information:** entanglement is more

# It took a long time for entanglement to be recognized as a revolutionary concept

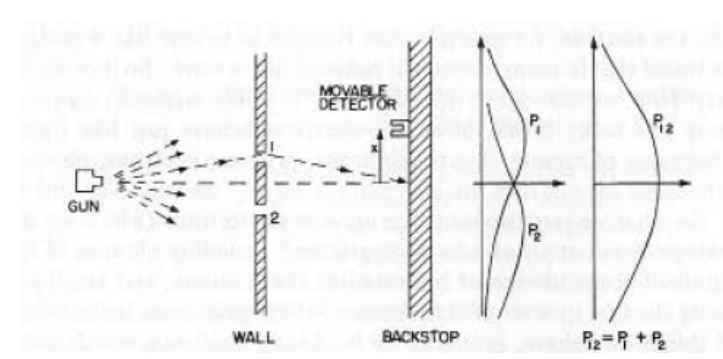
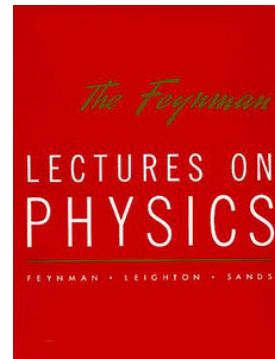
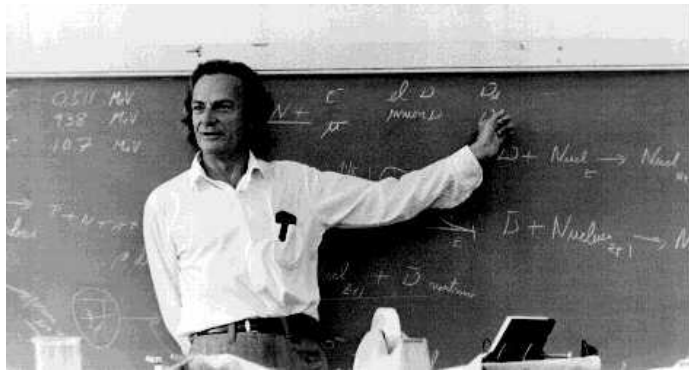

## Wave particle duality for a single particle: the only mystery (1960)

*In this chapter we shall tackle immediately the basic element of the mysterious behavior in its most strange form. We choose to examine a phenomenon which is impossible, absolutely impossible, to explain in any classical way, and which has in it the heart of quantum mechanics. **In reality it contains the only mystery.***

*This point was never accepted by Einstein... It became known as the Einstein-Podolsky-Rosen paradox. But when the situation is described as we have done it here, there doesn't seem to be any paradox at all...*

# It took a long time for entanglement to be recognized as a revolutionary concept

*we always have had (secret, secret, close the doors!) we always have had a great deal of difficulty in understanding the world view that quantum mechanics represents. At least I do*

Simulating Physics with Computers

Richard P. Feynman 1982

*I've entertained myself always by squeezing the difficulty of quantum mechanics into a smaller and smaller place, so as to get more and more worried about this particular item.*

*It seems to be almost ridiculous that you can squeeze it to a numerical question that one thing is bigger than another. But there you are-it is bigger than any logical argument can produce*

**and then...**

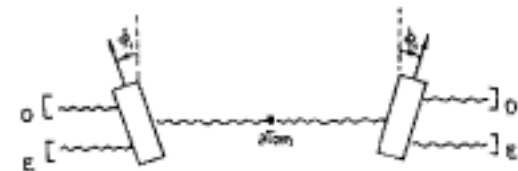

# Entanglement: a resource for quantum information

The understanding of the extraordinary properties of entanglement has triggered a new research field: quantum information

Hardware based on different physical principles allows emergence of new concepts in information processing and transport:

- Quantum computing (R. Feynman 1982, D. Deutsch 1985 )
- Quantum cryptography (Bennett Brassard 84, Ekert 1991)
- Quantum teleportation (BB&al., 1993; Innsbruck, Roma 1997)
- Quantum simulation (Feynman 1982, Hänsch and col. 2002)

Entanglement is at the root of most of the schemes for quantum information



# Quantum Cryptography: Key Distribution with entangled photons (Ekert)

Alice and Bob select their analysis directions  $a$  et  $b$  randomly among 2, make measurements, then send publicly the list of all selected directions

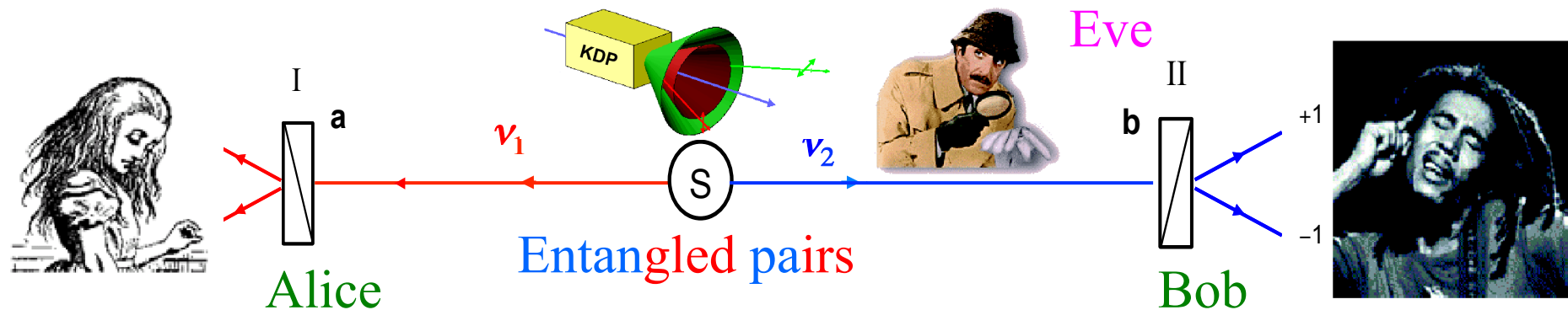

Cases of  $a$  et  $b$  identical : identical results  $\Rightarrow$  2 identical keys

Presence of Eve detected by doing a Bell's inequalities test.

In Quantum Mechanics, a spy always leaves a footprint

The security is guaranteed by the fundamental laws of QM in contrast with classical cryptography (assumption on maths and technology of adversary)

# Quantum computing?

A quantum computer could operate **new types of algorithms** able to make calculations **exponentially faster** than classical computers.

**Example: Shor's algorithm for factorization of numbers: the RSA encryption method would no longer be safe.**

What would be a quantum computer?

An ensemble of **entangled quantum bits**  
(qubit: 2 level system)

**Entanglement  $\Rightarrow$  massive information  $2^N$**

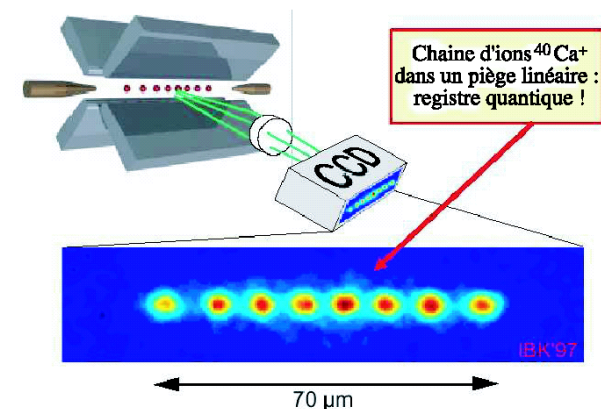

**A dramatic problem: decoherence:** hard to increase the number of entangled qubits

**Nobody knows if such a quantum computer will ever work:**

- Needed:  $10^5 = 100\,000$  entangled qubits
- Record: 14 entangled qubits (R. Blatt)

Would be a kind of Schrödinger cat



# Quantum simulation

**Goal:** understand a system of many entangled particles, absolutely impossible to describe, least to study, on a classical computer (Feynman 1982)

**Example:** electrons in solids (certain materials still not understood, e.g. high  $T_C$  superconductors)

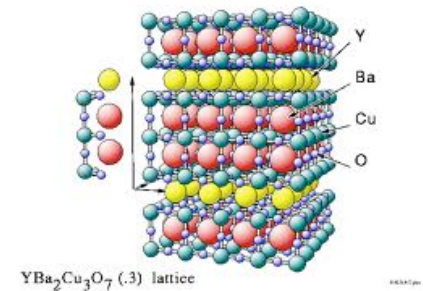

**Quantum simulation:** mimick the system to study with other quantum particles "easy" to manipulate, observe, with parameters "easy" to modify

**Example:** ultracold atoms in synthetic potentials created with laser beams

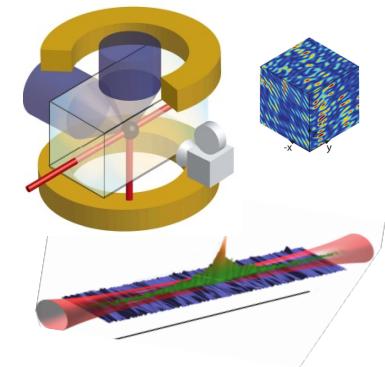

- Can change density, potential parameters
- Many observation tools: position or velocity distributions, correlations

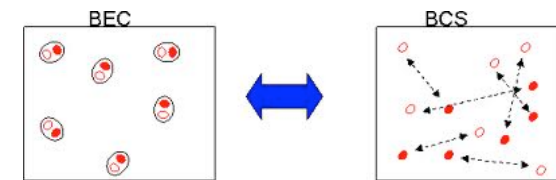

# Quantum simulator of the Anderson transition in a disordered potential

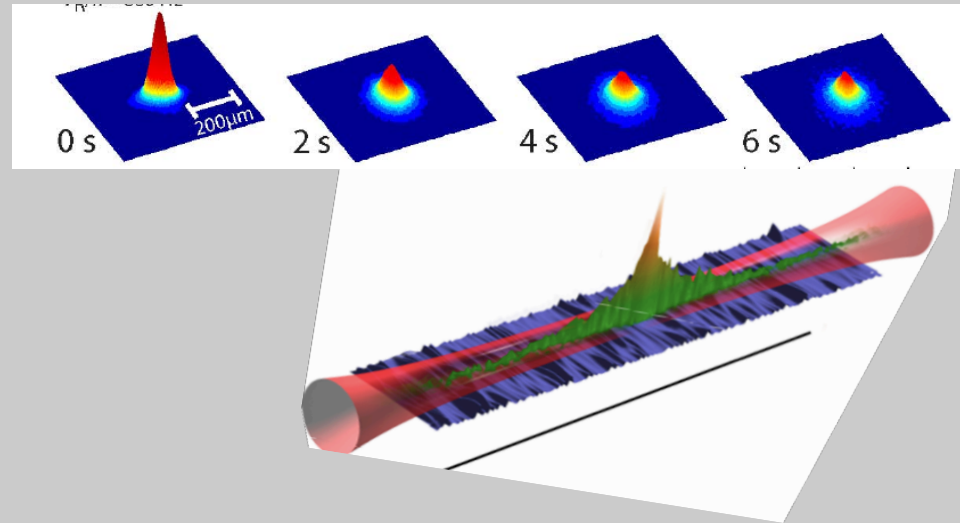
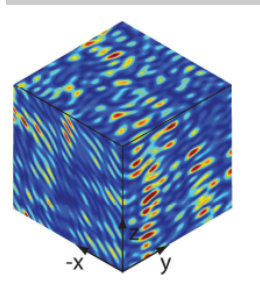
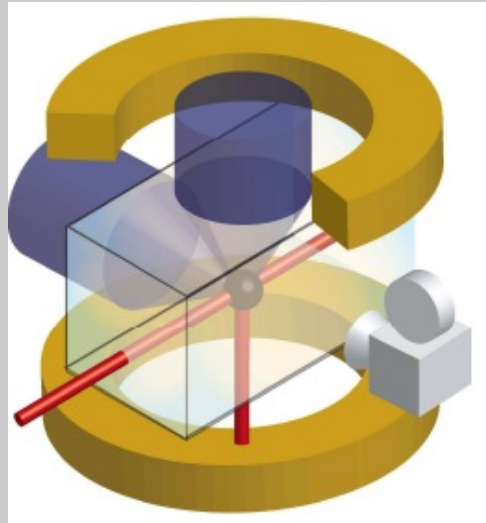

Atoms suspended, released in the disordered potential created with lasers. Absorption images

Direct observation of a localized component, with an exponential profile (localized wave function)

Similar experiments in Florence (Inguscio's group)

bichromatic lattice (non-periodic)

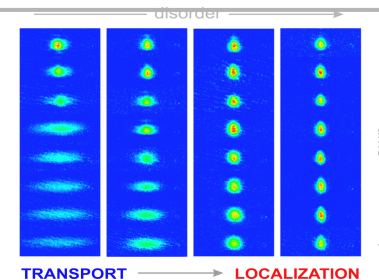
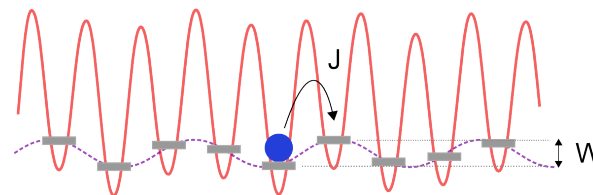

# A new quantum age

## Two concepts at the root of a new quantum era

### Entanglement

- A revolutionary concept, as guessed by Einstein and Bohr, strikingly demonstrated by Bell, put to use by Feynman et al.
- Drastically different from concepts underlying the first quantum revolution (wave particle duality).

### Individual quantum objects

- experimental control
- theoretical description (quantum Monte-Carlo)

Examples: **electrons**, atoms, **ions**, single photons, **photons pairs**

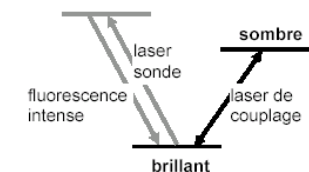
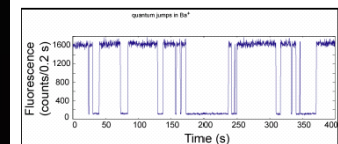
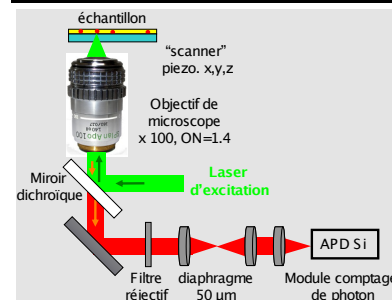
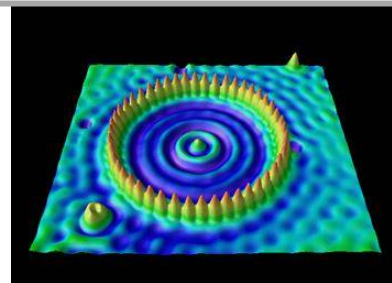

# Visionary fathers of the second quantum revolution

- **Einstein** discovered a new quantum feature, entanglement, different in nature from wave-particle duality for a single particle
- **Schrödinger** realized that entanglement is definitely different
- **Bohr** had the intuition that interpreting entanglement according to Einstein's views was incompatible with Quantum Mechanics
- **Bell** found a proof of Bohr's intuition
- **Feynman** realized that entanglement could be used for a new way to process information

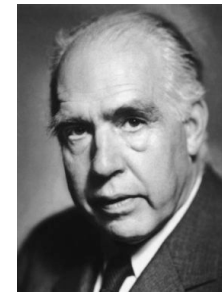
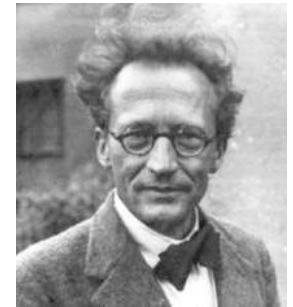

We stand on the shoulders of giants!

# Standing on shoulders of giants

The best-known use of this phrase was by Isaac Newton in a letter to his rival Robert Hooke, in 1676:

"What Descartes did was a good step. You have added much several ways, and especially in taking the colours of thin plates into philosophical consideration. If I have seen a little further it is by standing on the shoulders of Giants."



Newton didn't originate it though. The 12th century theologian and author John of Salisbury used a version of the phrase in a treatise on logic called *Metalogicon*, written in Latin in 1159. Translations of this difficult book are quite variable but the gist of what Salisbury said is:

"We are like dwarfs sitting on the shoulders of giants. We see more, and things that are more distant, than they did, not because our sight is superior or because we are taller than they, but because they raise us up, and by their great stature add to ours."